

D30, N85-16967

MECHANICAL FEATURES OF THE  
SHUTTLE ROTATING SERVICE STRUCTURE

John M. Crump  
Reynolds, Smith and Hills  
Jacksonville, Florida

ABSTRACT

With the development of the Space Shuttle launching facilities, it became mandatory to develop a Shuttle Rotating Service Structure to provide for the insertion and/or removal of payloads at the launch pads. The Rotating Service Structure is a welded tubular steel space frame 189 feet high, 65 feet wide, weighing 2,100 tons, bridge which rotates about a pivot column at one end and travels on two 8 wheel trucks at the opposite end. This structure, as shown in Figure 1, has three basic support points. At the pivot column the structure is supported on a 30 inch diameter hemispherical bearing. At the opposite terminus the structure is supported on two truck assemblies each having eight 36 inch diameter double flanged wheels.

INTRODUCTION

There was no known "first" Shuttle Rotating Service Structure upon which to adapt, develop, and base various fundamental decisions. Thus because of its first of a kind requirement, a number of interrelated functional features had to be determined simultaneously. The fundamental purpose of this structure is to position a 50 foot wide, 45 foot deep by 130 foot high environmentally controlled payload changeout room in a mated position with the Orbiter Cargo Bay such that payloads can be inserted and/or removed without exposure to the outside environment, following which the structure can be moved away from the launch pad during launch of the Shuttle from the Mobile Launchers. Certain features of the existing Saturn vehicle launch pad together with the existing flame trench and existing Mobile Launcher Mount Mechanism also influenced and placed restraints on the configuration of the Rotating Service Structure. Other related factors which influence the mechanical features of this structure are: location of Fixed Service Structure, Cabin Access Arm, routing of fuel piping systems and electrical services from the pad to the Orbiter, locations of Orbiter access requirements, hinged access stairs to tail service masts and Orbiter contingency access locations, Cargo Bay door torque arm hoists and access platforms, motor operated bi-fold 65 foot high doors, pneumatic environmental seals, payload canister hoisting and guide rails, HVAC and hypergol spill emergency purge system, telescopic platform for access to interior of Orbiter Cargo Bay, and related configuration of Launch Pad. All previous launch facilities utilized movable structures that moved to remote locations for vehicle launches. The approach used for the Space Shuttle is a relatively fast moving structure that remained in the immediate vicinity of the launch environment. The challenge clearly was to design a Rotating Service Structure that achieved all of the related functional requirements. The Rotating Service Structure was designed to satisfy these interrelated functions, and the significant mechanical features are described in this paper.

FROM CHALLENGE TO ACHIEVEMENT

Thus at the program's inception an intensive effort was made to investigate all feasible alternatives, innovative approaches and techniques in order to meet the challenge. Fundamental to the challenge was the question of how to provide for insertion and/or removal of payloads 15 feet in diameter by 65 feet long weighing up to 65,000 pounds within a controlled environment and without "hard physical contact" with the Space Shuttle Cargo Bay. The synergistic features demanded that this activity be accomplished using a rotating structure that could be moved into a mated position with the Orbiter and subsequently moved to a retracted position for Space Shuttle launch without interfering with the normal movement of the Space Shuttle to the launch pad from the Vehicle Assembly Building. The rotating service structure achieved this objective. Handling of the payload canister was explored using a variety of different innovative approaches, including movement through the rear, top and bottom of the rotating service structure. The technique selected was the most innovative and offered the highest degree of operational simplicity which would result in the maximum reliability. Basically the technique included a payload canister having an exterior mold line matching that of the Orbiter around the Cargo Bay. This provided for a synergistic effect whereby the side of the rotating service structure which mated with the Orbiter could be configured to mate with the payload canister and the Orbiter using the same environmental seal features. The payload hoisting machinery was located on top of the rotating service structure and provided the means for hoisting the payload canister to and from the pad surface, mating the canister with the payload changeout room environmental seals, opening the 65 foot tall payload changeout room doors, and opening the payload canister doors, all without exposing the payload to the

ambient environment. In this position, the payload can be removed from the canister into the payload changeout room, payload changeout room doors closed, canister doors closed, canister lowered to pad surface, and subsequently the rotating service structure rotated into mated position with the Orbiter. See Figure 2.

Once mated with the Orbiter, the same pneumatic seals that mated with the payload canister are used to provide an environmental seal with the Orbiter. Thus the 65 foot tall payload changeout room doors can be opened, the Orbiter cargo bay doors open and the payload inserted into, or removed from, the Orbiter Cargo Bay without exposure to the ambient environment. See Figure 3.

Since the rotating service structure performs a variety of other Shuttle related support functions, it remains mated with the Orbiter until the appropriate time in the launch countdown at which time it is rotated to its retracted position for launch. The entire front side of the rotating service structure is configured to allow for mating with the Orbiter with approximately 6 inches clearance between "hard points," thereby allowing for personnel access to numerous Orbiter access locations. See Figure 8.

Other secondary functions which illustrate innovative solutions to challenging requirements include flip down access platforms and pneumatic hoists, located on the payload changeout room 65 foot high bi-fold motor operated doors, for handling and installation of "torque arm" that must be installed on the Orbiter Cargo Bay doors prior to opening these doors while the Orbiter is in the vertical position at the launch pad. Flip down access stairs are provided on both sides of the rotating service structure providing access to the tail service masts and the Orbiter. Additional features of major rotating service structure elements are included in the following discussions and illustrated in the appended Figures 1 through 10.

#### BASIC STRUCTURE

The basic structure, as shown in Figure 1, is a tubular steel space frame bridge spanning 160 feet from the pivot column at one end to the two 8 wheel drive trucks at the other end. Central to the structure is the Payload Changeout Room which, in its mated position with the Orbiter Cargo Bay, determined its relative location to the Launch Pad and Flame Trench. The pivot column is located just outboard of the Mobile Launcher clearance envelope and in line with the front truss of the structure. At the outer end of the structure the two truck assemblies travel on a double 175 pound rail system having a 3 foot gauge. Mechanical wedge type tiedowns are provided at each terminus of the rail system. The 160 foot radius of the rail system being determined by the Mobile Launcher Mount Mechanism clearance on the opposite side of the flame trench from the pivot column. Thus the Rotating Service Structure rotates about a pivot column with two electric motor driven drive trucks traveling on a 160 foot radius curved track system.

#### PIVOT COLUMN AND BEARINGS

The pivot column is 42 inches outside diameter by 33 inches inside diameter. At the top of this pivot column, as shown in Figure 2, is a bearing assembly comprised of a 30 inch diameter ASTM B 148-955-HT aluminum bronze hemispherical thrust bearing race rotary on a 41 inch diameter ASTM A182-304 S.S. Alloy steel thrust bearing, the hemispherical ball. Just below this main support bearing is a 61 inch diameter side thrust bearing race and ball. This pivot bearing assembly has a 6 foot 2 inch diameter, A441 housing with a removable cover retained in the housing by means of a tapered shear key ring, thereby allowing for bearing changeout in the unlikely event the need should ever arise. The vertical resultant load support at this bearing assembly during rotation of the structure is in the order of 2,000,000 pounds (1,000 tons).

A lower side thrust bearing is provided on the pivot column to accommodate resulting side loads and is configured similarly to the side thrust bearing at the top of the column.

Figure 4 shows the 3 point support system comprised of the pivot column top hemispherical bearing assembly and two eight wheel drive truck assemblies. The relative size of the top hemispherical bearing assembly is illustrated in Figure 5 as it was being assembled on the ground prior to erection onto the pivot column during initial construction. Figure 5D shows the bearing assembly erected onto the pivot column.

#### BEARING CHANGE OUT

The bearing at the top of the pivot column incorporates provisions for installing six hydraulic jacks which in conjunction with three bearing changeout bolts will allow for complete bearing changeout should the need for repair ever occur. The jacks and locking belts allow the load to be removed from

the bearings after which the housing cover can be removed and the bearings subsequently removed from the housing, repaired and/or replaced.

The lower side thrust bearing assembly incorporates similar means for bearing changeout. An interesting feature of the hemispherical side thrust bearings is that the ball can be rotated 180 degrees to allow insertion or removal from the race. Thus the top side thrust bearing is made in one piece. The lower side thrust bearing is made in three segments to allow installation and/or removal from around the pivot column.

The uniqueness of the pivot column and bearing assemblies resides in their not so obvious relative simplicity together with the means to allow for the unlikely need for bearing repairs and/or changeout.

#### DRIVE TRUCK ASSEMBLIES

The configuration and functional requirements of the Rotating Service Structure made it necessary for the structure to travel on a 160 foot radius curved track utilizing two drive truck assemblies, thereby providing a stable three point support system for the structure. Each truck assembly has a resultant vertical load during rotation on the order of 1,400,000 pounds during rotation. The question of single rail versus double rail resolves itself down into a question of space requirements for the truck assemblies. Utilizing 36 inch diameter wheels a total of 8 wheels are required on each truck assembly. On a single rail, the length of the truck assembly when incorporated into a load equalization system would be extremely long. The length of single rail truck assemblies could not be utilized due to Space constraints when the structure is mated with the Orbiter and also when rotated to the retracted position. Thus a double rail truck assembly was selected as most feasible for this application.

Each truck assembly is comprised of four two wheel bogies connected to a structural wellment frame by means of load equalization pins. At one end of the truck assembly the load equalization system incorporates two load equalization pins perpendicular to one another, thereby providing load equalization not only along the axis of the rails but also between the two rails. This system functions much like a tricycle. Each truck assembly is 8 feet wide by 20 feet long, weighing in the order of 70,000 pounds. See Figures 6A and 6B.

The truck assembly is driven by four 15 HP D.C. drive motors which are capable of moving at any continuous speed between 1/8 inch per second and 4 inches per second when delivering maximum rated torque. Each individual 2 wheel bogie has a drive motor connected to the two wheels through a gear reducer and gear train. The control system is a four quadrant regenerative D.C. drive system with solid state components capable of maintaining a preset speed during varying wind conditions that would try to accelerate or decelerate the structure during rotation. The control system is split into two sections, each section driving 1/2 of the number of drive motors. The two drive units are interconnected with a load sharing logic system that will allow any combination of drive motors to provide the necessary driving force.

#### THERMAL EXPANSION/CONTRACTION OF STRUCTURE

Mounted on top of each drive truck assembly is a hemispherical ball joint which is connected to the main 36 inch diameter, tubular structural members supporting the Rotary Bridge Structure. This assembly will accommodate the normal thermal expansion and contraction of the 160 foot long structure while maintaining load equalization onto the "tricycle" type load equalization system of the main truck frame. See Figure 7.

#### HURRICANE TIE DOWNS

Incorporated into each main truck frame weldment is a provision whereby the two side skirts move between two related tie down plates located on the pad surface. Once the structure is positioned at either of its two extreme operating positions, four steel wedges can be inserted thereby locking the structure into position. Unique with the tiedown system is the capability of jacking the trucks up approximately 1/2 inch and moving the wedges in further, thereby placing the load onto the wedges during hurricane load conditions. This allows the wheels and bogies to be designed for a lesser load condition of 40 knot winds during rotation as opposed to 120 knot hurricane wind loads. This feature also allows for removal and/or replacement of truck components, should the need arise. See Figure 6C. Details of the drive trucks and hurricane tie downs are best seen in Figure 7.

### PAYLOAD CHANGEOUT ROOM (PCR) MAIN DOORS AND PCR-TO-ORBITER SEALS

To provide for payload changeout without exposing the payloads to the outside environment, two sets of two-panel bi-fold doors 29 feet wide by 62 feet high are provided. These doors together with the PCR-to-Orbiter seals provide the means whereby this can be accomplished. After the Rotating Service Structure is moved into its mated position with the Orbiter, the pneumatic seals are inflated into contact around the periphery of the cargo bay doors of the Orbiter. Following this operation, the cavity space between the exterior of the main doors and Orbiter Cargo Bay is cleaned with an air wash which is part of the PCR environmental control system. After the cleaning operation the main doors are opened, following which the Cargo bay doors may be opened and payload changeout operations conducted. The main doors also provide hinged platform and hoist features whereby a special torque arm can be installed onto the Orbiter Cargo bay doors to allow their operation when in the vertical position. See Figure 8.

### PAYLOAD GROUND HANDLING MECHANISM (PGHM)

This system located inside the PCR can be described as a bridge crane supporting a 217 ton manipulator for insertion or withdrawal of the 15 foot diameter by 60 foot long by 65,000 pound shuttle payloads into the Orbiter cargo bay. This system was designed by NASA and FMC.

### PAYLOAD ACCESS PLATFORMS

Five adjustable platform access levels are provided on each side of the PCR to provide access to any size payload configuration. Each platform is composed of an 8 plank adjustable module whereby the planks are pneumatically adjusted in and out to interface and provide access to any payload configuration. See Figure 10A.

### ORBITER CARGO BAY ACCESS

An adjustable cantilevered access platform is provided to allow for access to the cargo bay interior payload attachment features. This platform in its retracted position is stored below the PGHM. When utilized, it is rolled out into position in front of the Cargo bay connected to hoisting cables and stabilizers. The platform can then be hoisted to any level of the vertical Cargo bay. Incorporated into the platform are two telescoping platform segments which can extend out into the Cargo bay, thus allow operating personnel access to any location inside the Cargo bay. See Figure 10B.

### PCR CONTROLLED ENVIRONMENT

The Payload Changeout Room (PCR) is a controlled environment room 50 feet wide by 45 feet deep by 130 feet high. The temperature, humidity, cleanliness and pressurization are controlled by circulating 52,000 cfm of air through HEPA filters mounted on the ceiling with the return air passing through a pre-filter bank and chilled water cooling coils located above the fan room. The room is maintained at 0.5 inch W.G. positive pressure to prevent outside air from entering the room. Provisions are also provided for shutdown of the normal HVAC cooling pressurization system in the event of toxic hypergolic propellant spillage within the PCR. Should a propellant spill occur, the normal HVAC system is changed to a fresh air purging system by the coordinated interlocks between control dampers outside air supply fan, and purge air exhaust fans. See Figure 9.

### 90 TON CANISTER HOIST

A 90 ton, 2 speed 176 feet left, payload canister hoist is located in the hoist room on the PCR roof. This hoist system provides the means for lifting from the launch pad, or lowering to the launch pad, a payload canister. The canister is raised into position in front of the PCR main doors and mated with the pneumatic seals similar to that which is done with the Orbiter. Thus a payload can be inserted into or removed from a canister without being exposed to the outside environment.

### ORBITER ACCESS PLATFORMS

A system of hinged flip down access platforms are provided for access to all required Orbiter access locations including a rolling window access ladder for Orbiter windows.

ORIGINAL PAGE IS  
OF POOR QUALITY

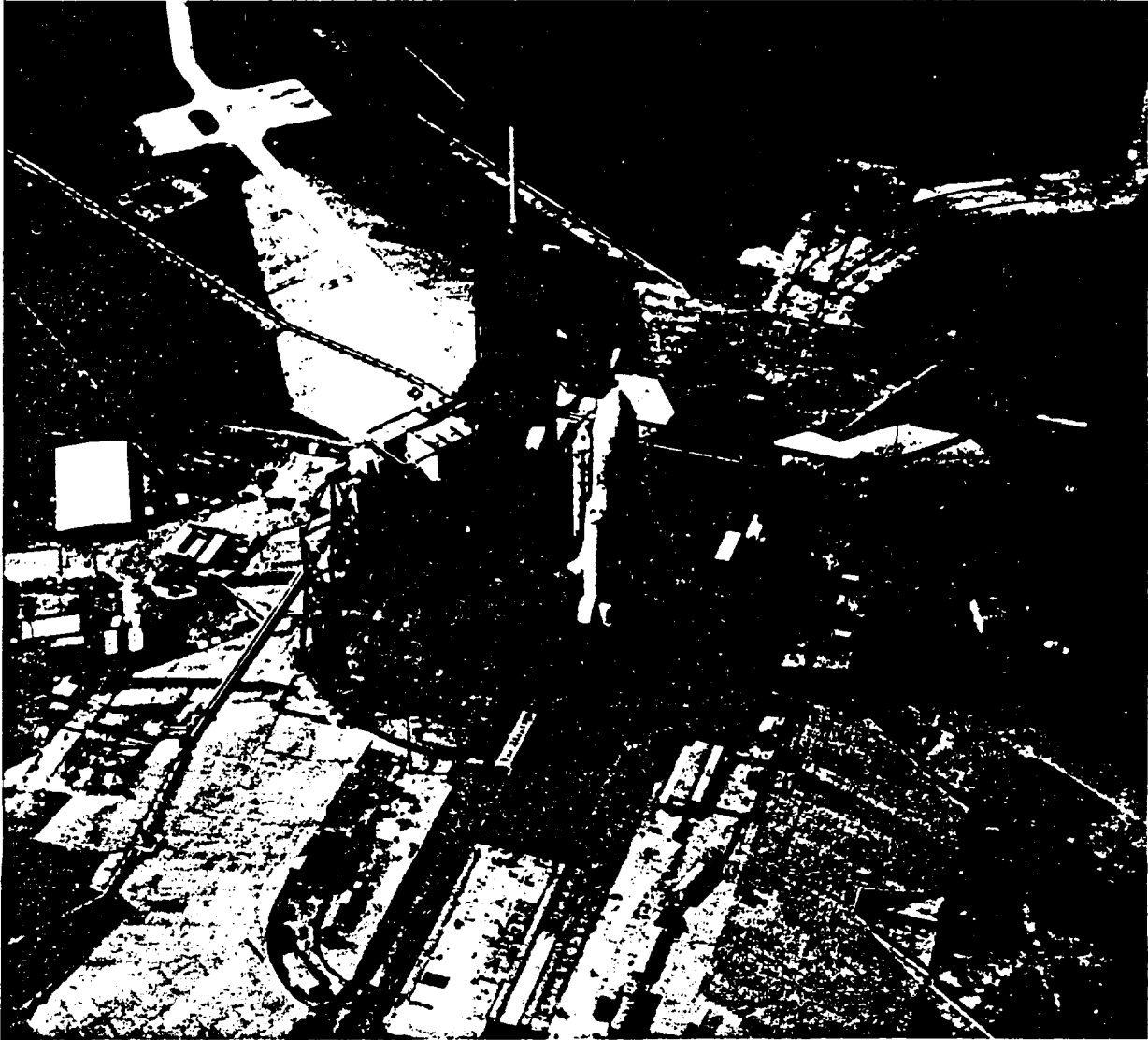

FIGURE 1. ROTATING SERVICE STRUCTURE SHOWN IN RETRACTED POSITION -  
SHUTTLE READY FOR LAUNCH

LOADING OF FOUR PAYLOADS

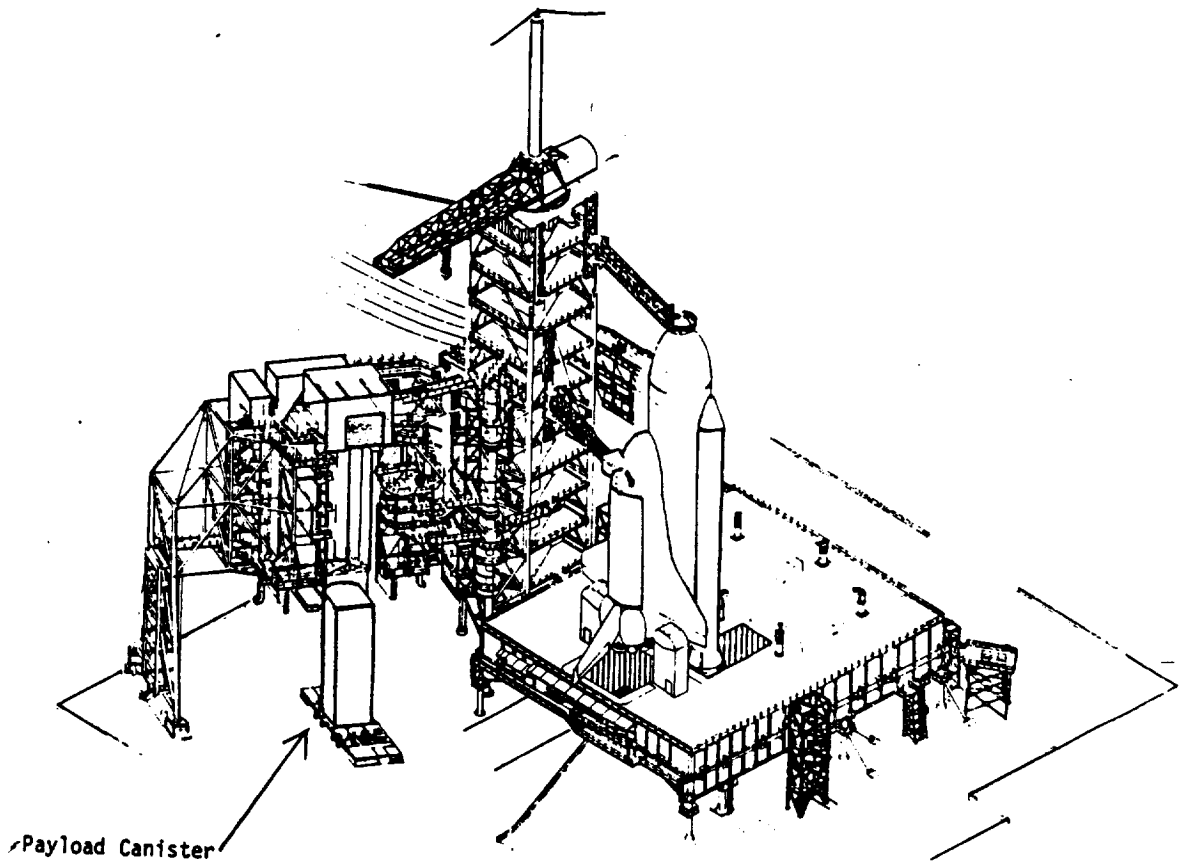

FIGURE 2. PAYLOAD CANISTER BEING HOISTED INTO PCR

ORIGINAL PAGE IS  
OF POOR QUALITY.

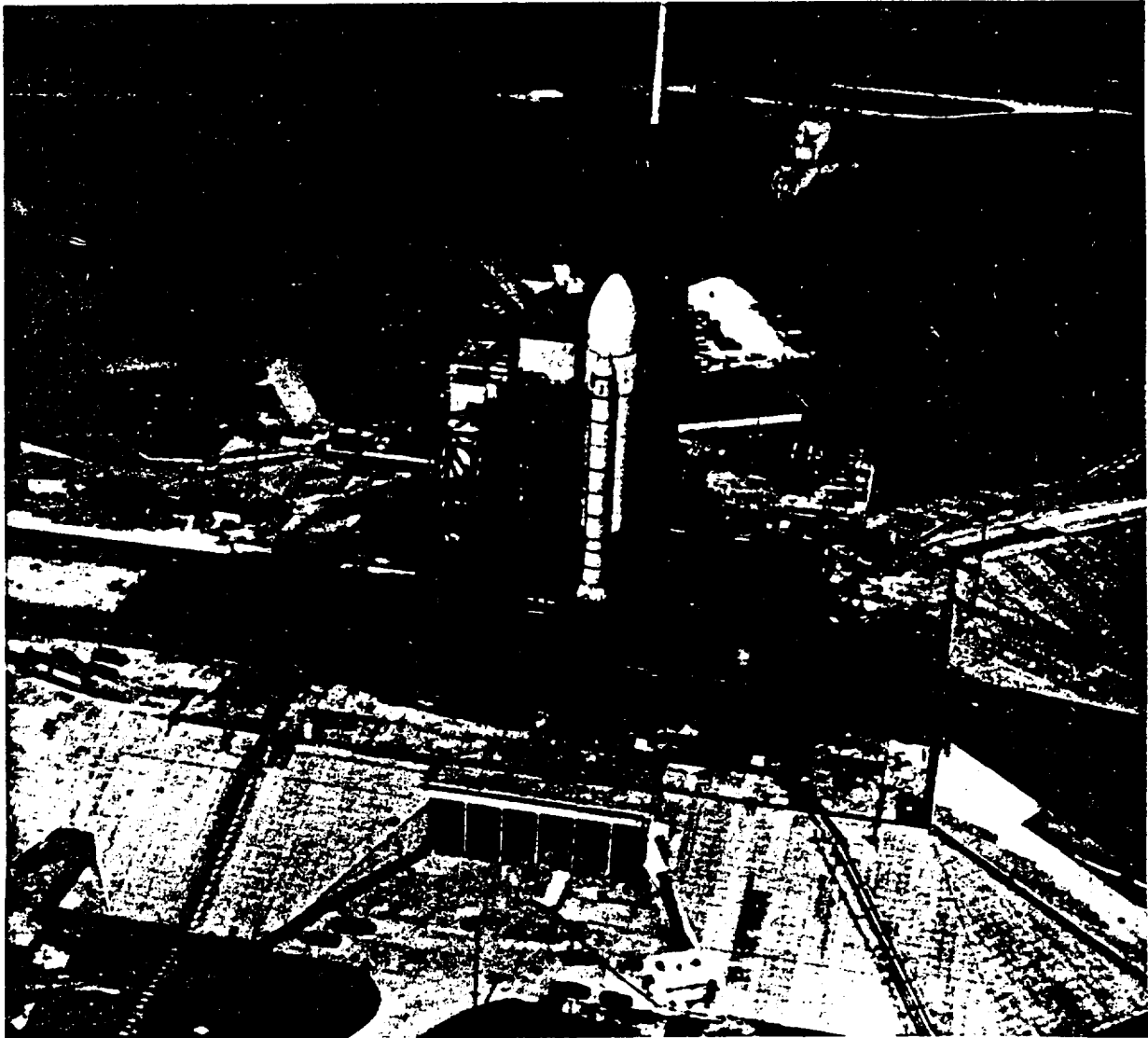
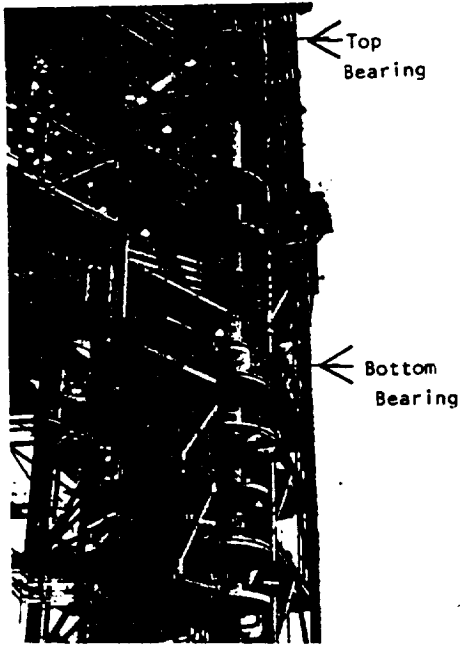

FIGURE 3. ROTATING SERVICE STRUCTURE SHOWN MATED WITH ORBITER FOR  
PAYLOAD INSERTION OR REMOVAL

... WIDE IS  
OF POOR QUALITY



Pivot column bearings and utility crossover system designed for 120° of rotation with access and utility around the pivot column.

Figure 4A

The RSS is rotated on a 3 point support system comprised of a pivot column, top bearing and 2 eight wheel drive trucks.

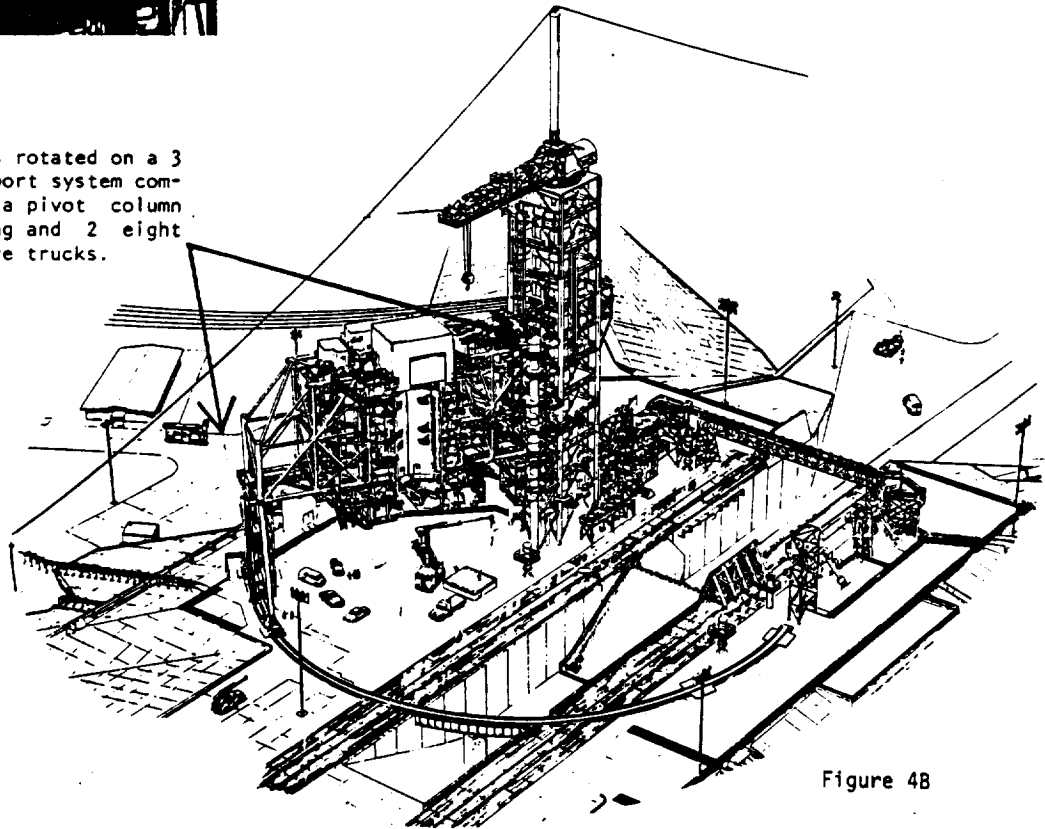

Figure 4B

FIGURE 4. 3 POINT SUPPORT SYSTEM



ORIGINAL PAGE IS  
OF POOR QUALITY



Figure 5A  
Top Bearing Housing & Pivot  
Column Being Assembled

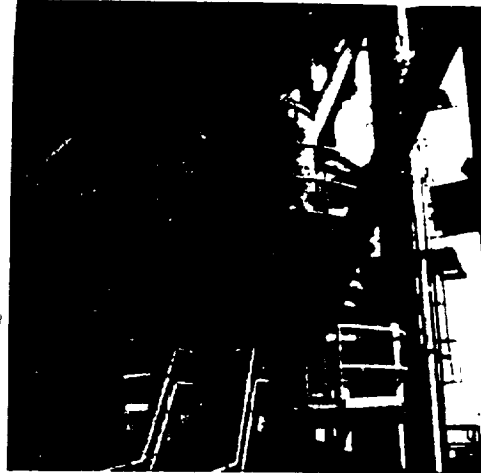

Figure 5D  
Top Bearing Assembly Erected  
on Top of Pivot Column

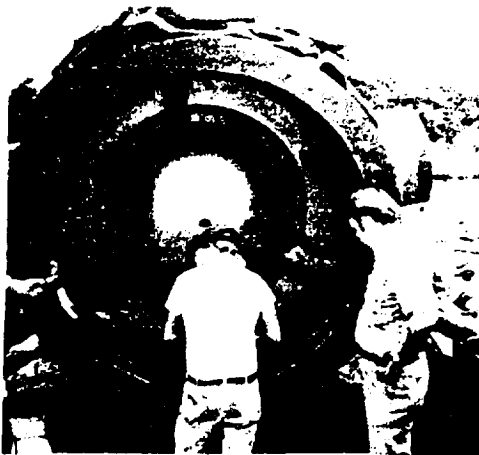

Figure 5B  
Top Hemispherical Bearing  
Assembled Inside Housing



Figure 5C

FIGURE 5. PIVOT COLUMN BEARING ASSEMBLY

ORIGINAL SOURCE OF POOR QUALITY

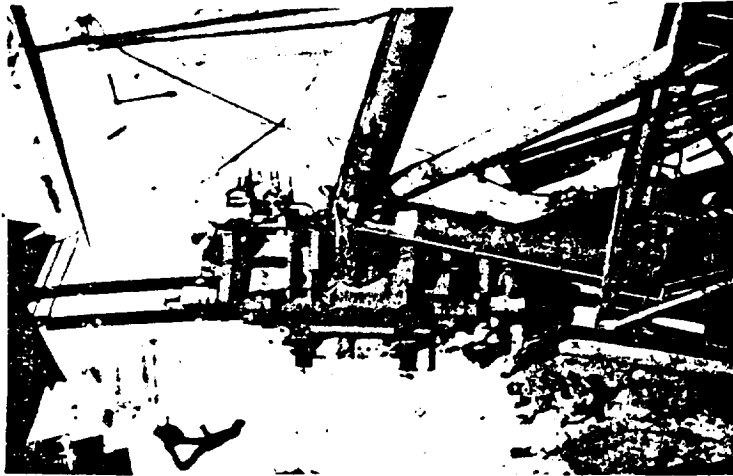

Figure 6A. Top View

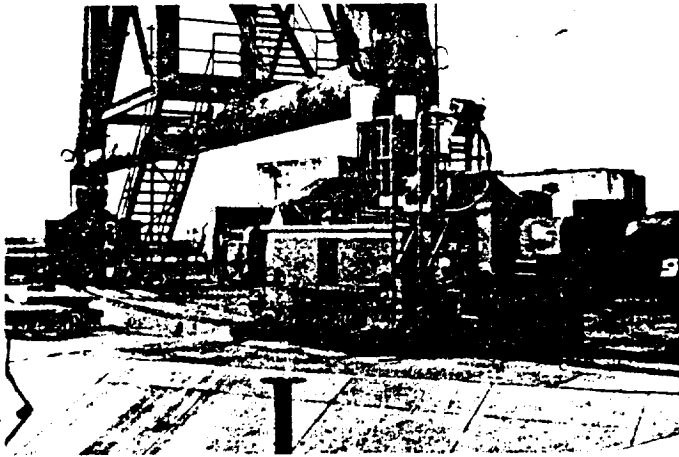

Figure 6B. Side View

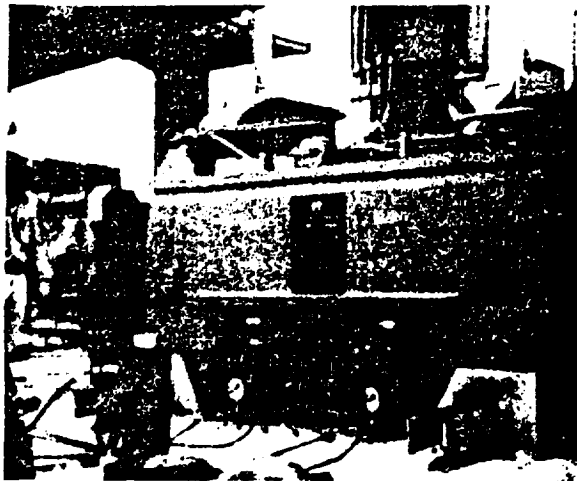

Figure 6C. Hydraulic Jacks and Locking Wedges

FIGURE 6. DRIVE TRUCK ASSEMBLIES



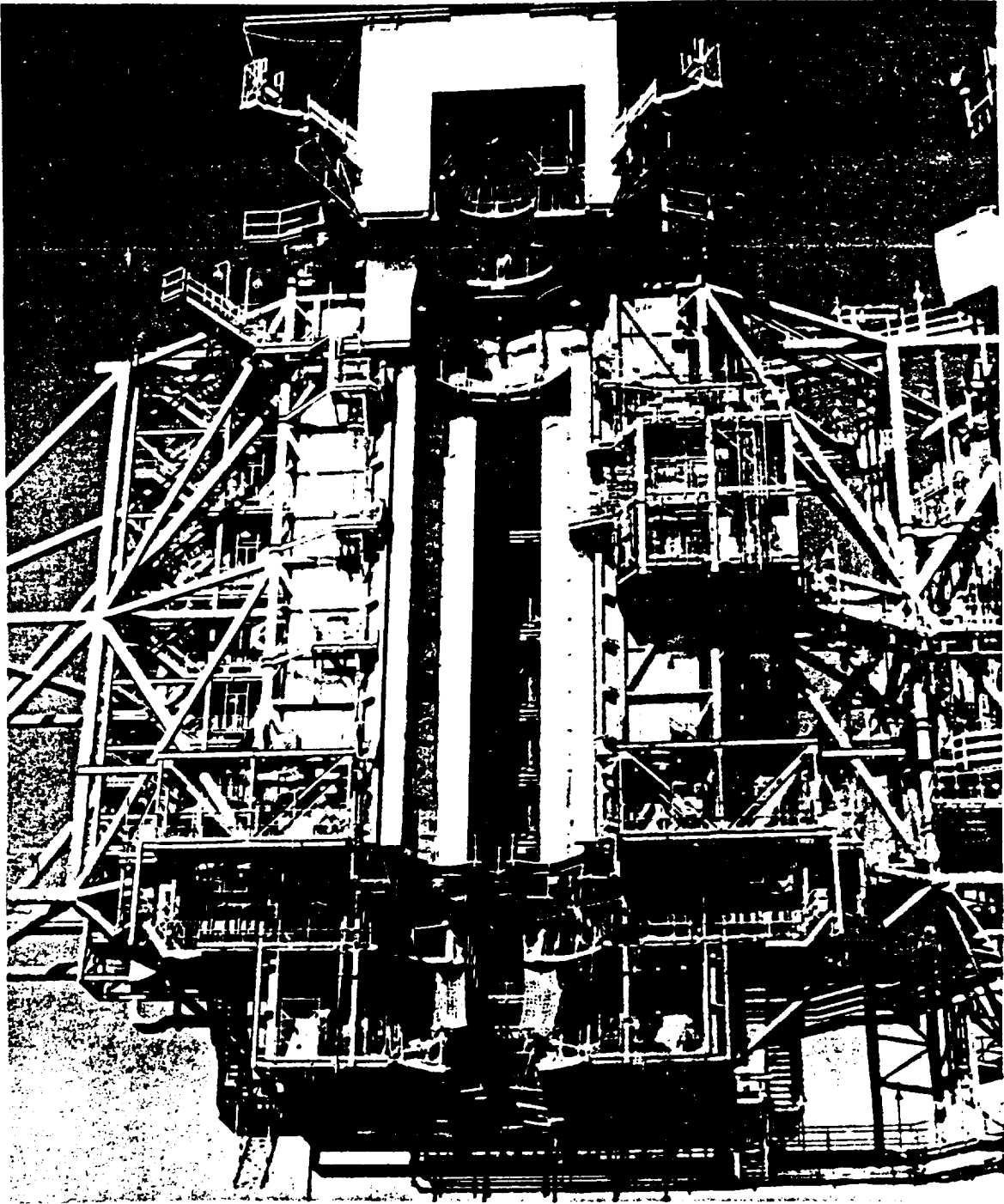

FIGURE 8. PCR MAIN BI-FOLD DOORS

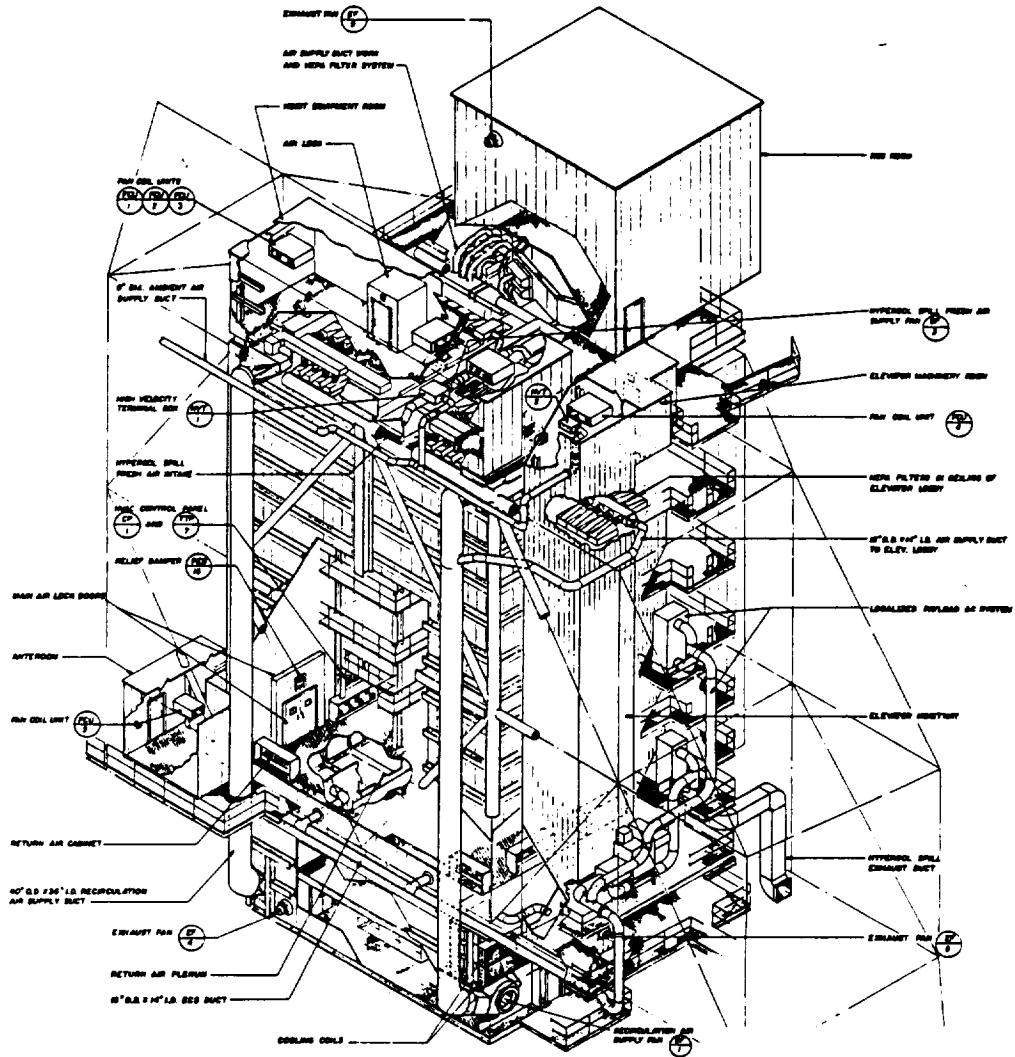

FIGURE 9. PCR CONTROLLED ENVIRONMENT SYSTEM



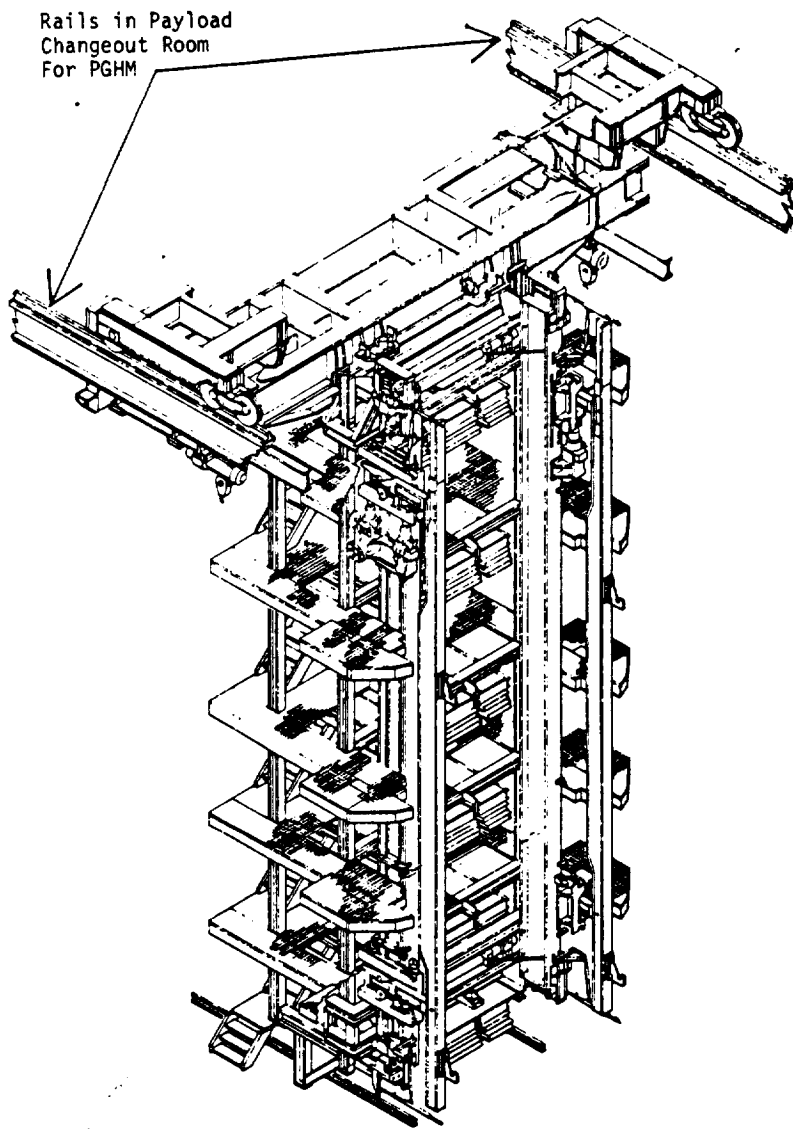

FIGURE 11. PAYLOAD GROUND HANDLING MECHANISM (PGHM)